



# GENIE<sup>®</sup> 702

Permanent Insertion Probe<sup>™</sup>

## Genie<sup>®</sup> Direct Drive<sup>™</sup> 702 Permanent Insertion Probe<sup>™</sup> Installation & Operation Instructions

### Tools & Materials

- Flathead screwdriver
- 1 3/4" wrench



4, rue des Roses - 69280 SAINTE-CONSORCE - France  
Tel: +33 478 878 945 - [info@soclema.com](mailto:info@soclema.com) - [www.soclema.com](http://www.soclema.com)

### Additional Information

- A ball valve is required, if not using the supplied cap.

### Safety Warnings

**⚠** Failure to abide by any of the safety warnings or operation of this device outside the limits stated below may result in equipment failure and serious injury or death.

- Stop turning the probe rack crank at any sign of resistance and observe the magnetic indicators on the housing or the body to confirm position of the probe.
- Be sure that only 3/4" NPT or larger fittings are used between the pipeline and the process ball valve.
- Internal diameter of any pipe component must be a minimal diameter of 0.75".
- Use of reducers, small pipe or fittings less than 3/4" NPT will cause damage and prohibit the installation.
- This product may vent while being installed, operated, or maintained. The user should follow company safety practices concerning Personal Protective Equipment (PPE) as well as any and all OSHA, state and local regulations.

### Model Identification

### - OVERVIEW

U.S. Patents  
8,616,228;  
7,886,624.

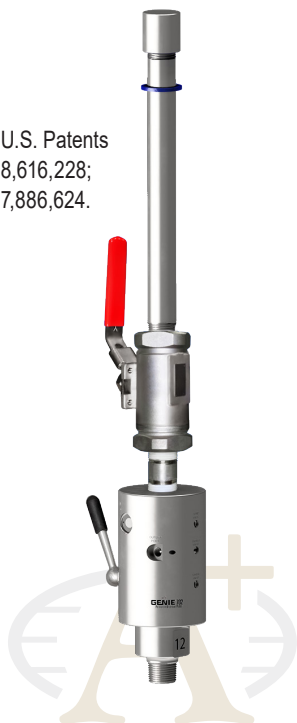

An ISO 9001:2015 certified company

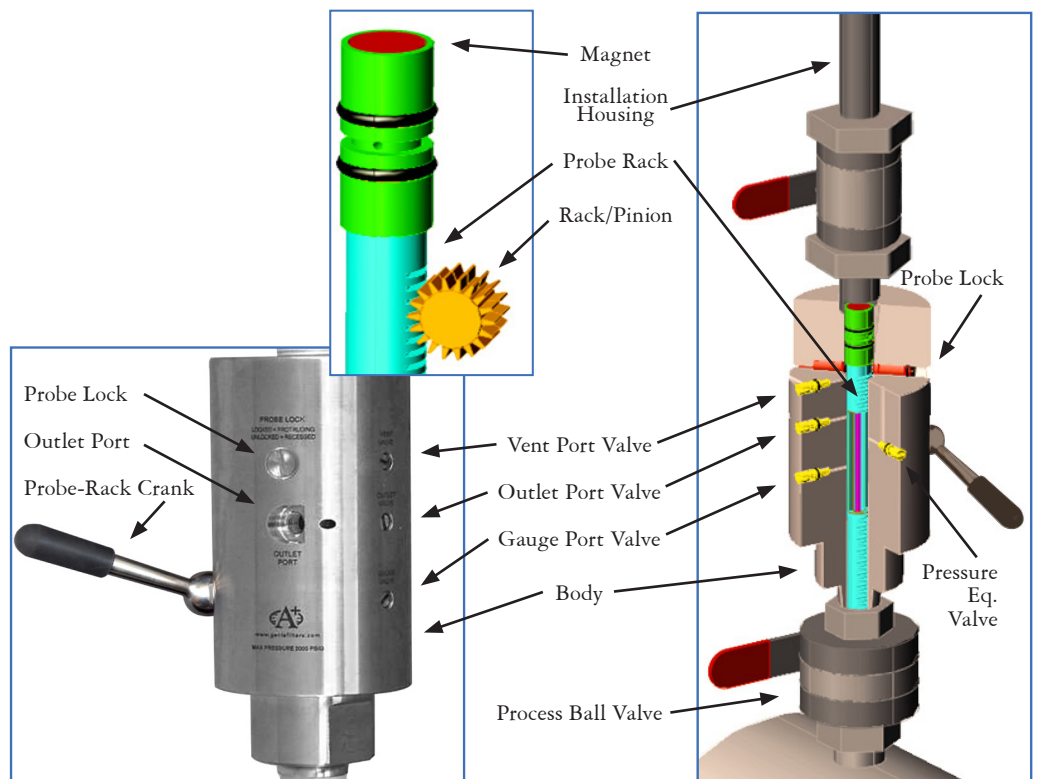

SCC-702-InsInstallationOperation\_110121

### Overview Instructions & Explanations

### - INSTALLATION

#### 1- Pre-inspect the probe

- 1.1 Make sure the 702 probe is fully retracted into its body and installation housing and that all integral valves are closed (clockwise). The probe lock should be in its unlocked position (fully recessed into the body). (Figure 1 & 2)
- 1.2 If using a factory supplied ball valve, confirm it is closed.

#### 2- Install to process valve

- 2.1 Apply thread sealant to the 702 NPT threads. (Figure 1)
- 2.2 The 702 should be installed onto a full-port NPT process ball valve (3/4" NPT min. size). This process ball valve should be in the closed position.
- 2.3 Thread the 702 body, hand tight, into the closed process full-port NPT ball valve. Use a wrench on the flats near the bottom of the 702 body to securely tighten/seal the NPT threads. The body may be damaged if over tightening occurs. (Figure 3)

**⚠ NOTE:** Teflon tape that contains nickel for stainless steel is preferred.

#### 3- Confirmation that integral valves are closed (Figure 4)

- 3.1 Confirm that all four 702 integral valves are closed (vent, outlet, pressure equalization, and gauge).
- 3.2 Connect 1/8" NPT fittings to the 1/8" NPT outlet port [and vent port if desired].

**⚠ NOTE:** The threaded vent port permits venting of toxic process gases to a safe area through a vent line.

- 3.3 Plug the pressure gauge port or connect a pressure gauge or pressure sensor to this port.

Figure 1

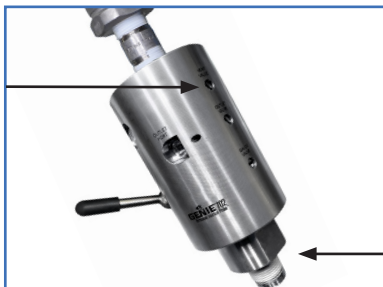

Figure 2

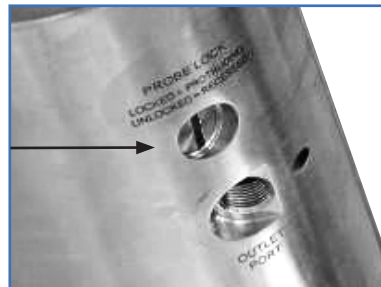

Figure 3

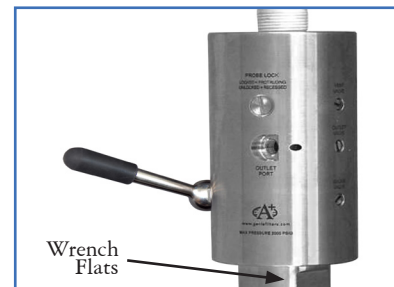
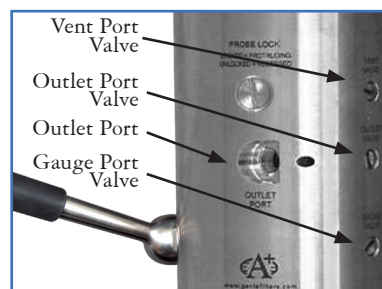

Figure 4\*



(continued)

\* The pressure equalization valve not shown in this view.



#### 4- Leak check

- 4.1 Confirm that all threads are securely tightened, that all valves are closed and that the installation housing is securely tightened onto the 702 ball valve attached to the body and open it.
- 4.2 Slowly open the process ball valve to pressurize the 702. Confirm that no leaks are present. If leaks are present, close the process ball valve and depressurize the 702 using the 702 integral vent valve. Re-seal the areas of concern and repeat this step from the beginning.
- 4.3 Check the position of the colored washer on the installation housing. If it is not held in place near the top of the installation housing by the magnet, then move it to that position. (Figure 5)

#### 5- Install the probe

- 5.1 With the process ball valve opened, insert the 702 probe into the pipeline by turning the 702 rack crank handle counterclockwise. The colored washer on the housing should be at the top end of the housing and it should follow and track the progress of the probe.

 **NOTE:** The rack crank should turn easily. Do not apply excessive torque to the handle.

#### 6- Magnetic Indicator

- 6.1 After the probe is fully inserted into the pipeline and has come to a mechanical stop, the magnetic position indicator in the body (Figure 6) should be pulled into the body. Recessed = No red showing. (Figure 7)

**Figure 5**

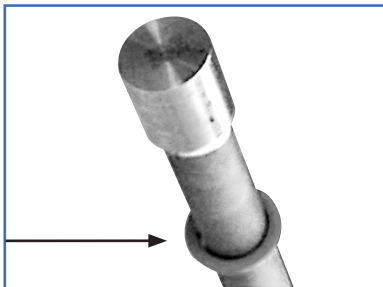

**Figure 6**

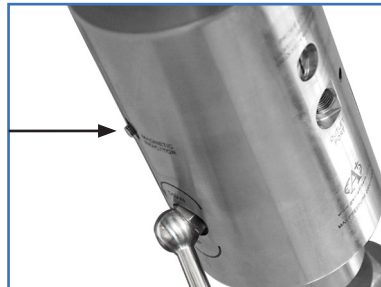

**Figure 7**

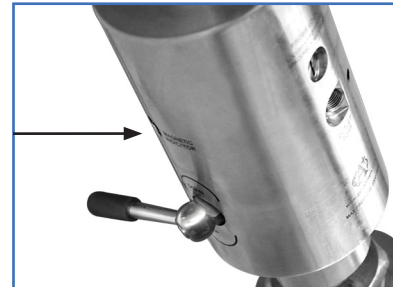

(continued)

**Overview Instructions & Explanations**

**- INSTALLATION**

**7- Lock the probe**

7.1 Rotate the probe lock counterclockwise so that it is locked. The probe lock will be protruding out of the probe body. (Figure 8 & 9)

**8- Vent & remove installation housing**

8.1 With the probe lock in its locked position, use a flat blade screwdriver to slowly open the vent valve (by turning it counterclockwise) to depressurize the 702 installation housing.

**⚠ NOTE:** The probe will move slightly upwards against the lock as the installation housing vents.

8.2 If using a ball valve on the body of the probe, close the valve at this time. (Figure 10)

8.3 Once the installation housing is completely depressurized, it may be unscrewed and removed from the 702 body. (Figure 10)

8.4 Once the housing is completely depressurized, close the integral vent port valve. If the housing length is over 3 feet in length, it is recommended that it be removed after the installation is complete. Failure to remove the long housing could enable great leverage to be placed on the 3/4" NPT threads and could result in damage or injury.

**⚠ CAUTION:** - If the pressure does not decrease to zero during this step, the installation may not have been successful.

- If the reason for the unsuccessful installation cannot be determined then contact your local A+ Corporation representative.

- The housing should only be removed after it has been completely depressurized.

**Figure 8**

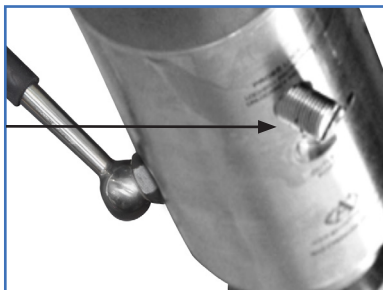

**Figure 9**

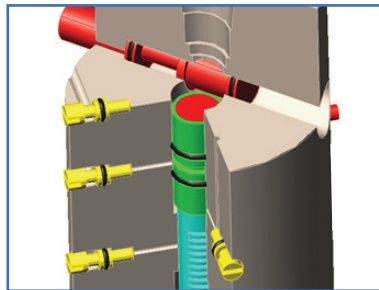

**Figure 10**

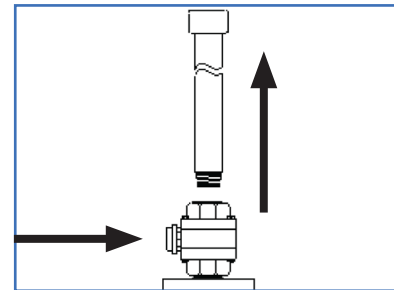

(continued)



**Overview Instructions & Explanations**

**- INSTALLATION**

9- Cap or install customer supplied ball valve

**NOTE:** If valve was not purchased with the probe, the default supplied cap on the 12" pipe nipple could be removed, and it can be replaced with a customer supplied full port 3/4" NPT ball valve. (Figure 12)

9.1 Apply thread sealant to the male threads of either a 3/4" NPT plug, the 12" long 3/4" pipe nipple included with the probe, a customer supplied or factory supplied full port 3/4" NPT ball valve.

9.2 **Option 1:** The customer supplied ball valve would allow you to simply add the 12" pipe nipple included with the probe or the probe length housing safely if any process seals were compromised (physically damaged, attacked by components in the gas, or failed over time). (Figure 11)

**Option 2:** The customer supplied ball valve would allow you to simply add the long housing without having to remove the 12" pipe nipple when full retraction of the probe is required or if the probe will not fully install after it had been retracted for pigging due to unforeseen circumstances. Be sure that each pipe section has the colored magnetic indicator washer. (Figure 12)

**Option 3:** Customer may choose to use 2 ball valves in combination for redundant protection. (Figure 13)

9.3 Once installation is complete, close the customer supplied ball valve(s).

10- Connect sample tubing

10.1 Confirm that external analyzers or devices are connected to the outlet port, then open the integral outlet port valve to permit gas flow through the outlet port. Do not allow uncontrolled flow from the outlet port. Excessive flow will cause an excessive pressure drop across the membrane and may force liquids if present through the membrane.

**Figure 11**

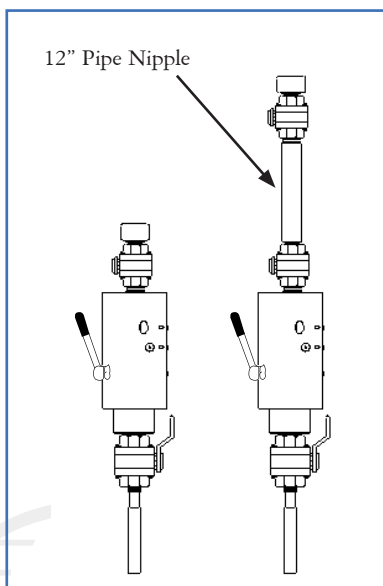

**Figure 12**

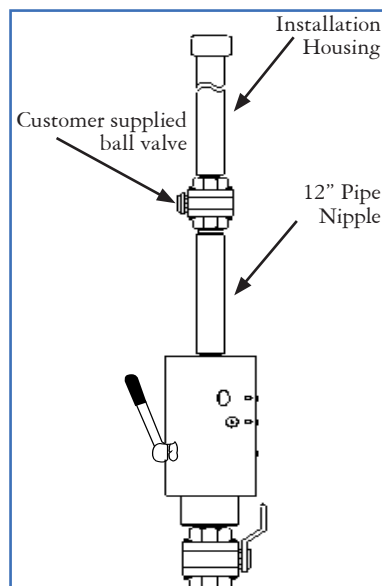

**Figure 13**

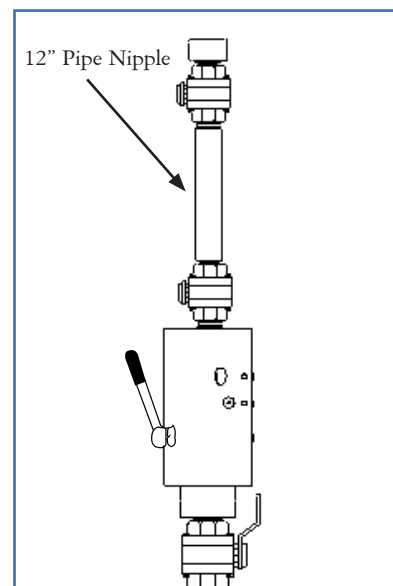

**Overview Instructions & Explanations**

**- REMOVAL**

- Removal refers to completely removing the probe from the process ball valve.
- Retraction differs from removal in that the probe is not completely removed from the process ball valve.
- Instead, the probe remains on the process ball valve, but the probe is retracted up into the 702 body and 12” pipe nipple so that the pipeline is cleared for maintenance such as pigging the line, etc.

[Retraction will be detailed after the removal section]

- 1- Connect installation housing** (If the 12” pipe nipple is connected and does not have a ball valve connected to the top, see next step.)
  - 1.1 Close outlet valve.
  - 1.2 Confirm that the probe lock is in the locked position (lock protrudes from the body), and then open the integral vent valve to confirm that the 12” pipe nipple is depressurized. No gas present.
  - 1.3 Remove the 12” pipe nipple or pipe plug and add the installation housing or if so equipped, then add the long housing to the top of the customer supplied ball valve. (Figure 1) May add installation housing to the ball valve of the 12” pipe nipple if it is configured as such.
- 2- Pressurize housing**
  - 2.1 Close the integral vent valve.
  - 2.2 With the long installation housing securely tightened in place, check the position of the colored washer on the installation housing. If it is not near the bottom of the installation housing, then move it to that position. (Figure 2)
  - 2.3 Pressurize the housing by slowly opening the integral pressure equalization valve and housing valves. (Figure 3)

**Figure 1**

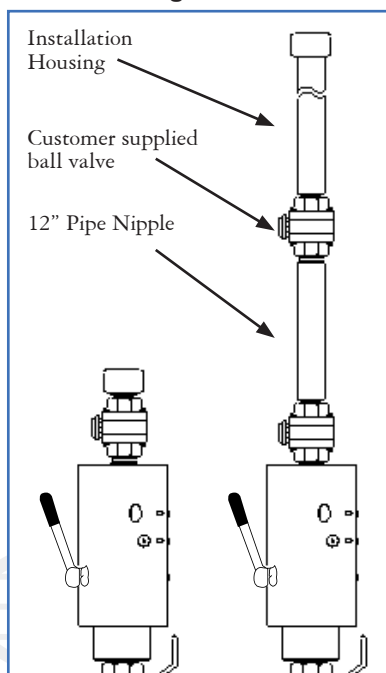

**Figure 2**

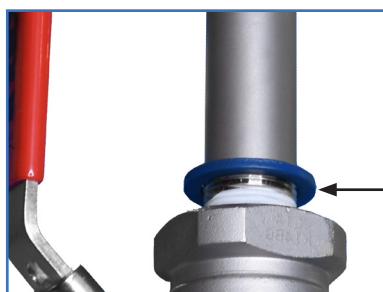

**Figure 3**

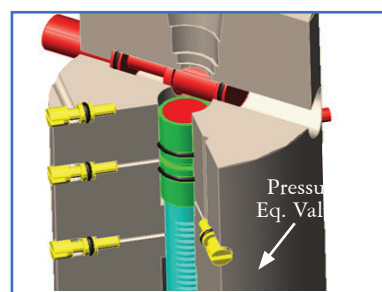

(continued)



### Overview Instructions & Explanations

### - REMOVAL

#### 3- Unlock probe

- 3.1 With the pressure now equalized, unlock the probe by rotating the probe lock clockwise until it is fully recessed into the body and comes to a mechanical stop. (Figure 4,5 & 6)

#### 4- Retract probe

- 4.1 With the pressure still equalized, retract the probe from the pipeline into the 702 housing by turning the rack crank clockwise. The colored washer on the housing should track the probe's position as it nears the top of the housing.

**⚠ NOTE:** The rack crank should turn easily. Do not apply excessive torque.

#### 5- Depressurize probe

- 5.1 With the probe fully retracted into the 702 (colored washer is near top of housing), close the process ball valve. (figure 7)  
 5.2 Next, depressurize the 702 (body and housing) by opening the integral vent port valve. (Figure 8)  
 5.3 After the 702 is completely depressurized, disconnect all 1/8" tubing from all ports.

#### 6- Disconnect probe

- 6.1 The 702 can now be removed from the closed process ball valve using a wrench on the wrench flats of the body. (Figure 9)

Figure 4

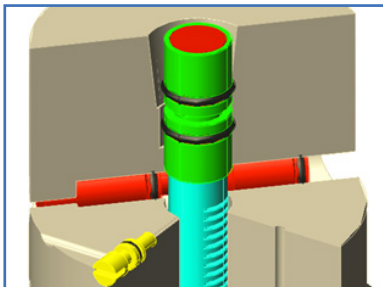

Figure 5

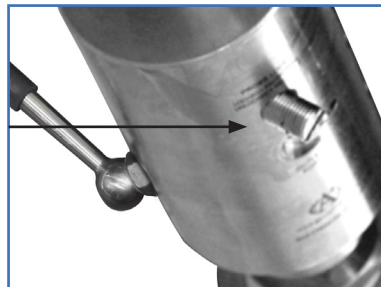

Figure 6

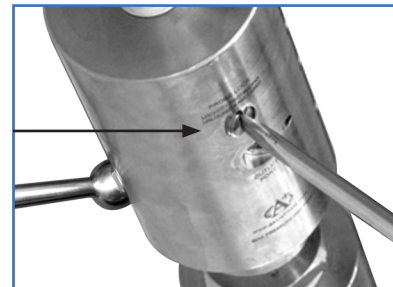

Figure 7

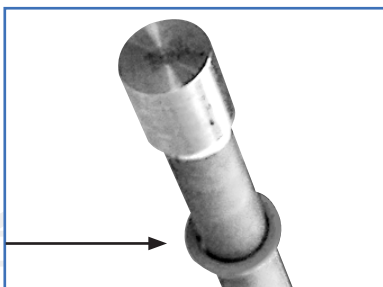
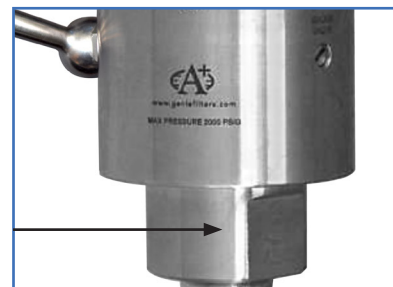

Figure 8



Figure 9



Genie®, Genie® Membrane Technology™, Genie® Membrane Probes™, are trademarks or registered trademarks of A+Corporation, LLC. All other referenced trademarks are the property of their respective owners. © 2012 A+ Corporation. All rights reserved.

**Overview Instructions & Explanations**

**- RETRACTION**

- Retraction differs from removal in that the probe is not completely removed from the process ball valve.
- Instead, the probe remains on the process ball valve, but the probe is retracted up into the 702 body and short 12” pipe nipple so that the pipeline is cleared for maintenance such as pigging the line, etc.

**1- Connect 12” pipe nipple**

- 1.1 Confirm that the probe lock is in the locked position (lock protrudes from the body).
- 1.2 If the pipe plug was used, open the integral vent port valve and remove the pipe plug. No gas should be present.
- 1.3 Then close the integral vent port.
- 1.4 Next, add the 12” pipe nipple. (Figure 1)
- 1.5 Check the position of the colored washer on the installation housing. If it is not near the bottom of the installation housing, then move it to that position. (Figure 2)

**2- Pressurize housing**

- 2.1 With the 12” pipe nipple securely tightened in place, pressurize the housing by slowly opening the integral pressure equalization valve. (Figure 3)

**Figure 1**

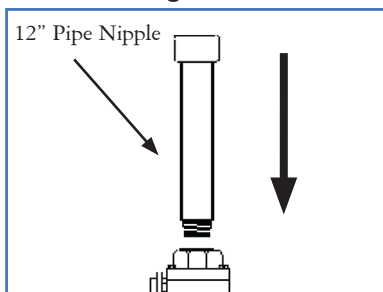

**Figure 2**

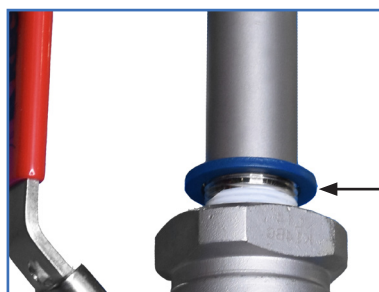

**Figure 3**

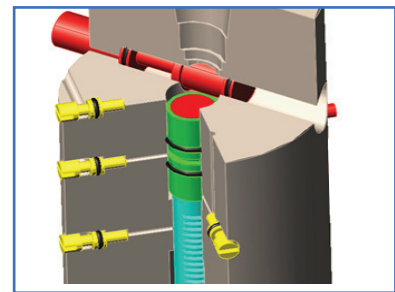

(continued)





### Overview Instructions & Explanations

### - RETRACTION

#### 3- Unlock probe

3.1 With the pressure now equalized, unlock the probe by rotating the probe lock clockwise until it is fully recessed into the body and comes to a mechanical stop. (Figure 4,5 & 6)

#### 4- Retract probe

4.1 With the pressure still equalized, retract the probe from the pipeline into the 702 housing by turning the rack crank clockwise. The colored washer on the housing should track the probe's position as it nears the top of the housing. (Figure 7 & 8)

**⚠ NOTE:** The rack crank should turn easily. Do not apply excessive torque.

Figure 4

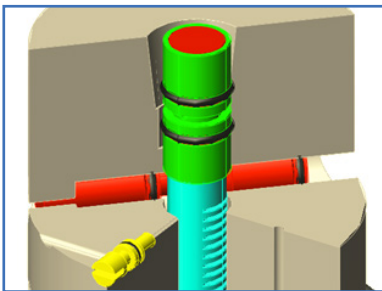

Figure 5



Figure 6

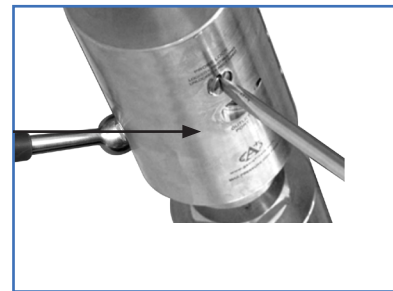

Figure 7

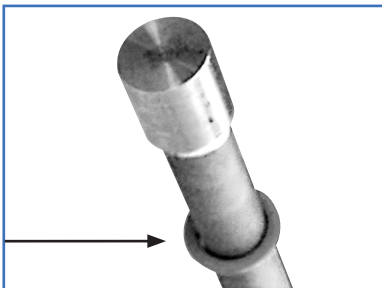
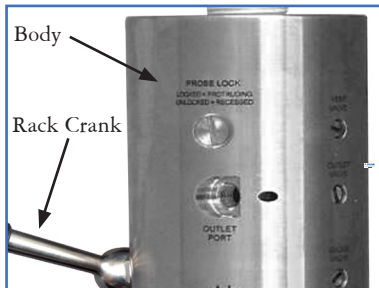

Figure 8



4, rue des Roses - 69280 SAINTE-CONSORCE - France  
Tel: +33 478 878 945 - [info@soclema.com](mailto:info@soclema.com) - [www.soclema.com](http://www.soclema.com)



An ISO 9001:2015 certified company

Genie®, Genie® Membrane Technology™, Genie® Membrane Probes™, are trademarks or registered trademarks of A+Corporation, LLC. All other referenced trademarks are the property of their respective owners. © 2012 A+ Corporation. All rights reserved.