

AVENGER™ 38

Particulate & Coalescing Filter



Avenger™ Model 38 Installation & Operation Instructions

Manufacturing Contact Information

A+ Corporation, LLC *Call for expert product application assistance:*
41041 Black Bayou Rd. Phone: (225)-644-5255 Website: www.geniefilters.com
Gonzales, LA 70737 Fax: (225)-644-3975 E-mail: sales@geniefilters.com

Safety Warnings

- ⚠ Failure to abide by any of the safety warnings below may result in equipment failure and serious injury or death.
 - ▶ Valve off the sample flow before installation.
 - ▶ Do not exceed any equipment pressure ratings.

Tools Required

- ▶ Four #10 screws for mounting bracket to panel.
- ▶ Screwdriver for mounting bracket to panel.

Technical Specifications

Technical Specifications

Maximum pressure rating	2,000 psig (137.9 barg)
Maximum temperature	300°F (149°C) *Actual limit depends on sealing material chosen. Refer to Temperature Range Comparison Chart.
Flow coefficients, Liquid C_v	Without element: 0.8
Element size	Outside Diameter: ~ 1.4" Inside Diameter: ~ 1.0" Length: ~ 2.5"
Port sizes	1/4" female NPT
Number of ports	5
Internal volume	50 cc
Wetted materials	Machined parts: 316/316L stainless steel / NACE compliant All other metal parts: stainless steel / NACE compliant Sealing material: User defined

Dimensions

Back View

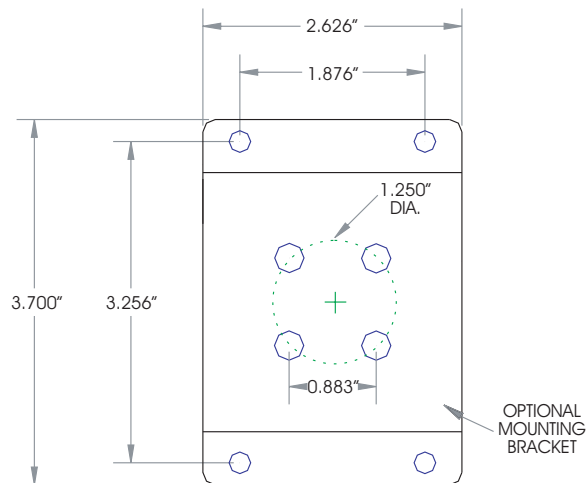

Side View

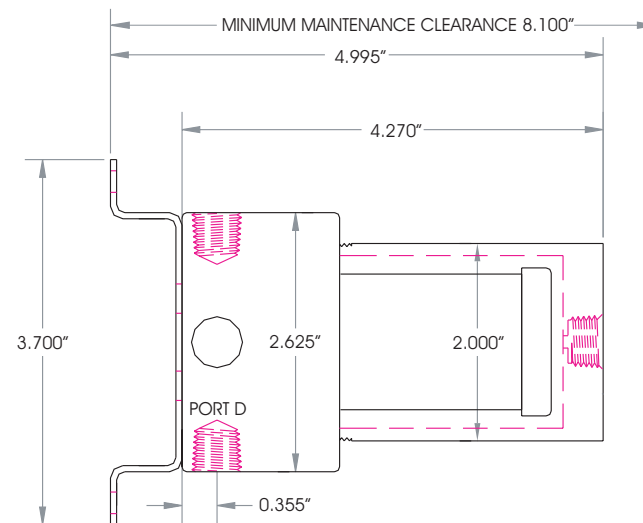

Installation Instructions

Install the mounting bracket onto the Avenger Model 33 or 38 as per the Mounting Bracket Installation Instructions included in A+ Corporation Mounting Bracket Kit P/N 33-509SS for Model 33 or P/N 38-509SS for Model 38. Aftermarket brackets may be mounted as per the mounting diagrams below. Mount the Avenger horizontally as shown in the diagram. Lock washers may be used on the lower 10-32 screws to tilt the filter as shown to ensure that liquids drain properly. "Port D" should be facing down as shown. An optional upstream pressure gauge may be installed in "Port E" or it may be plugged. The Model 33 has 1/2" NPT ports (except for the 1/4" NPT gauge "Port E") and the Model 38 has 1/4" NPT ports. Refer to the "Application" drawing on Page 2 for tubing connection instructions.

Application Drawing

Application #1: Particulate Removal From Sample Gas - No Membrane

Application #2: Particulate Removal From a Liquid Stream - No Membrane



Horizontally Mounted

To second analyzer
Bypass or slipstream (filtered)
or side mounted pressure gauge
(downstream pressure) or plug

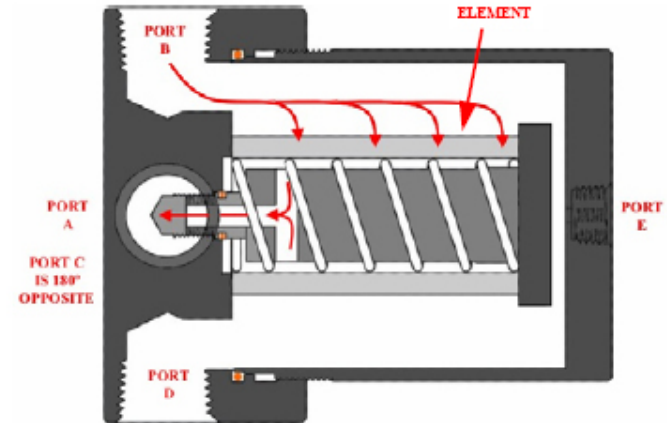
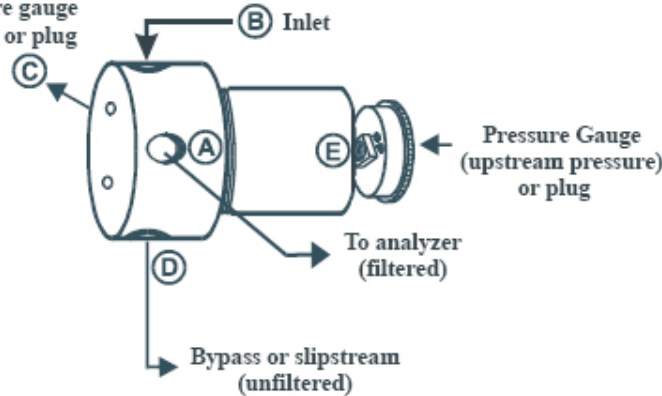

Model 33 & 38 are mounted horizontally. Sample (liquid or gas) with particulate enters port **B** and flows from the element exterior to its interior. An unfiltered bypass stream leaves port **D**. Clean, filtered sample flows from the element interior to Ports **A** and **C**

* Flow is from element exterior (outer) to its interior (center).

Application #3: Coalescing Of Liquids And Removal Of Solids From Sample Gas- No Membrane



Horizontally Mounted

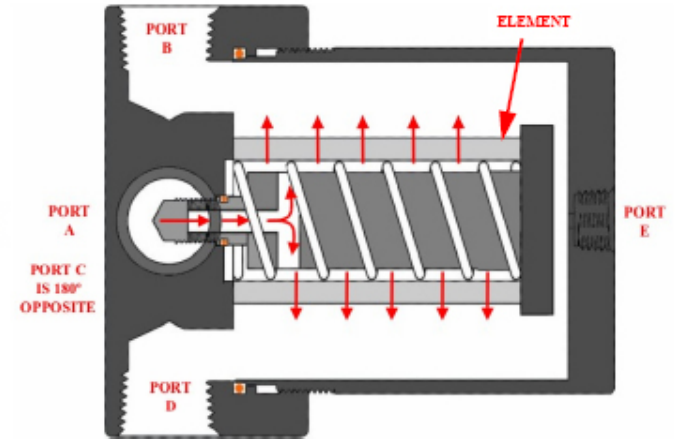
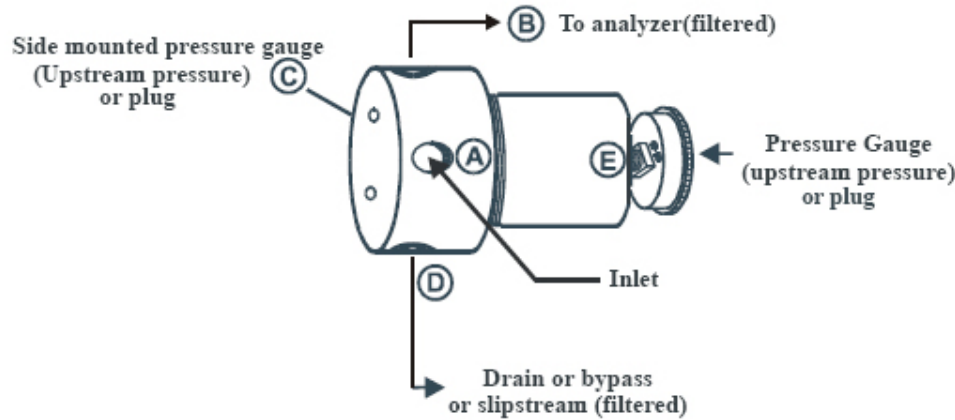

Model 33 & 38 is mounted horizontally. Gas sample with entrained liquids and particulate enters port **A** and flows from the element interior to its exterior. A filtered bypass stream leaves port **D**. Sample gas flows through the element. Liquid coalesced by the element drains through Port **D**. Clean sample gas leaves Port **B**.

**Flow is from the element interior (center) to its exterior (outer).*

Model Numbering & Additional Part Numbers

Model Numbering & Additional Part Numbers

Your model number is determined by your specific needs. Choose options below.

Sealing material	0 = Fluoroelastomer	1 = Perfluoroelastomer	(other materials available upon request)
Element type	07CFS = 0.1 micron coalescer fluorocarbon	SS10 = 10 micron stainless steel	
Mounting bracket accessory	Part # 38-509SS (sold separately)		

How to build the model number:

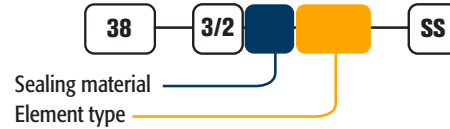

How to build the replacement o-ring kit number:

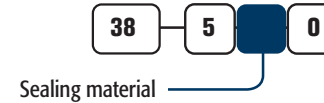

How to build the replacement filter element number:



Replacement filter kit contains 5 total. O-ring replacement kit contains all assembly o-rings.



4, rue des Roses - 69280 SAINTE-CONSORCE - France
Tel: +33 478 878 945 - info@soclema.com - www.soclema.com



An ISO 9001:2008 certified company



Genie®, Avenger™, Liquid Block™ and Genie® Membrane Technology™ are trademarks or registered trademarks of A+ Corporation, LLC. All other referenced trademarks are the property of their respective owners.